

MANUAL BOOK



WM – 200C

**C02 / MAG/ MIG /AUTOMATIC
WELDING MACHINE**

Prolegomenon

We do very appreciated for your selecting our products.

It can be composed the WM-200C CO₂ARC Welding system equipped with SB-10 wire feeder and welding gun .It has many characteristic such as easy Arc starting .good Arc springiness .adjustable arc thrusting ,low splash,good welding form ,easy welding operation.

The CO₂ semi-auto Arc welding machine model WM-200C is advanced welding machine and it can be compared with foreign products.

This operation manual can help you for the machine installation, operation and maintenance correctly and safely.Pay attention to the points as following.

- . Installation of the power cord. Be grounded correctly.
- . Don't put sundries under the welder.Otherwise it will affect the heat released.
- . Installation for the positive and negative cable of the power output.
- . Welding voltage selection
- . Welding current selection

The amendment right and the explanation right of the manual belonging to my company.
We have no special notice if the manual is amended.

1. Main characteristic and suitable range

This kind of welding power Model WM-200C is taken foreign advanced technology to develop and manufacture . It has the perfect performance of high quality ,good reliability, quick speed of welding current, steady welding process,low splash and good welding form . Anyway, It becomes the welding very easy.

1.1 Structure of the WM-200C CO₂ semi-auto Arc welding machine

a.The name of the model

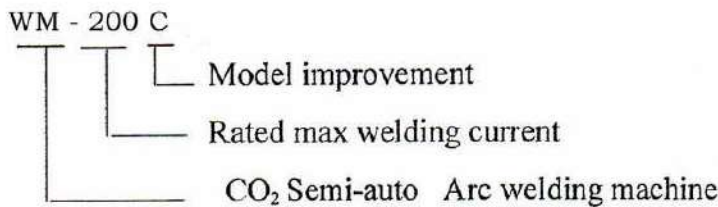

b. Composing of the product

This product is composed by three parts as following

- ★ Power source (WM-200C)
- ★ welding gun

1.2 Suitable range of the WM-200C

- ★ Suitable material: low-carbon steel, stainless steel.
- ★ Thickness of the material:low-carbon steel and stainless:more than 1.5mm .
- ★ Suitable position:all positions
- ★ Suitable wire : ϕ 0.8,1.0,solid wire/flux cord wire ,

1.3 Characteristic of WM-200C

- ★ Wide output current 40-200A: 0.8 -----40-150A
1.0-----50-200A

- ★ Steady welding process,low splash,easy control,good welding form.
- ★ Low starting of wire feed

2.Main technical Data :

- ★ Input Voltage 1~220V ;50/60Hz
- ★ Rated Input current 35A
- ★ Rated Input power 7 . 6KVA
- ★ No-load Voltage 40V(max)
- ★ Voltage adjusting Range $16 \pm 3V \sim 40 \pm 3V$
- ★ Current output Range 40~200A

WM - 200 C FRONT PANEL

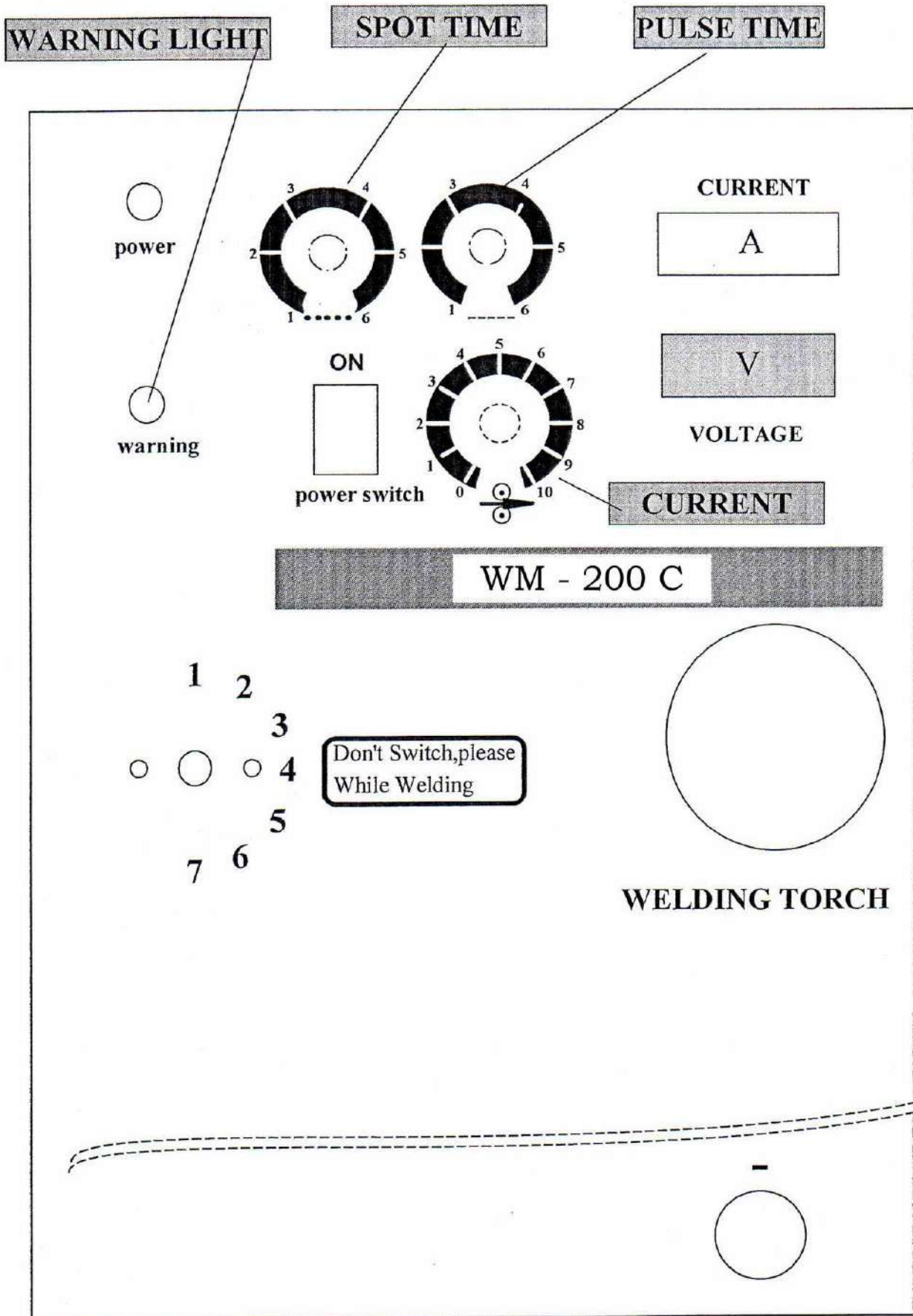
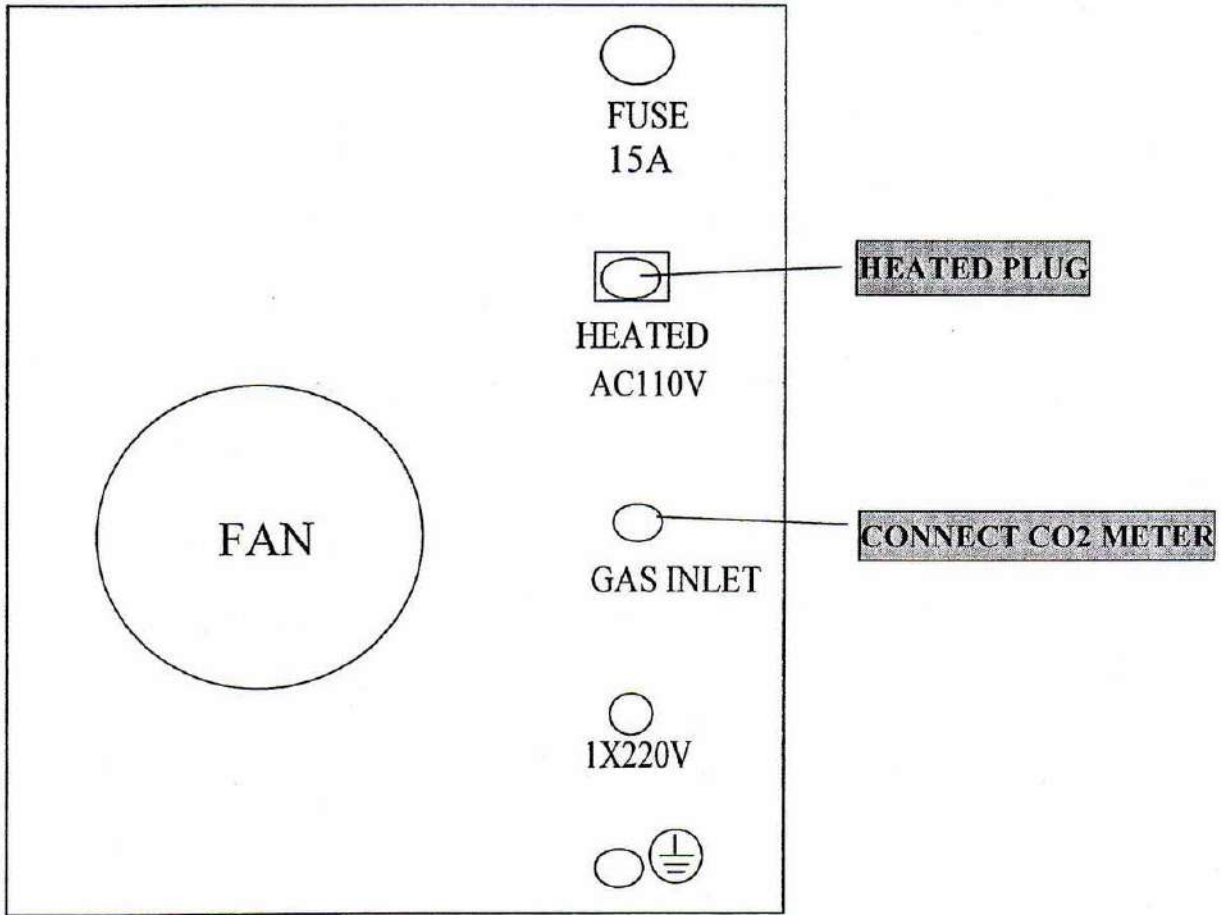
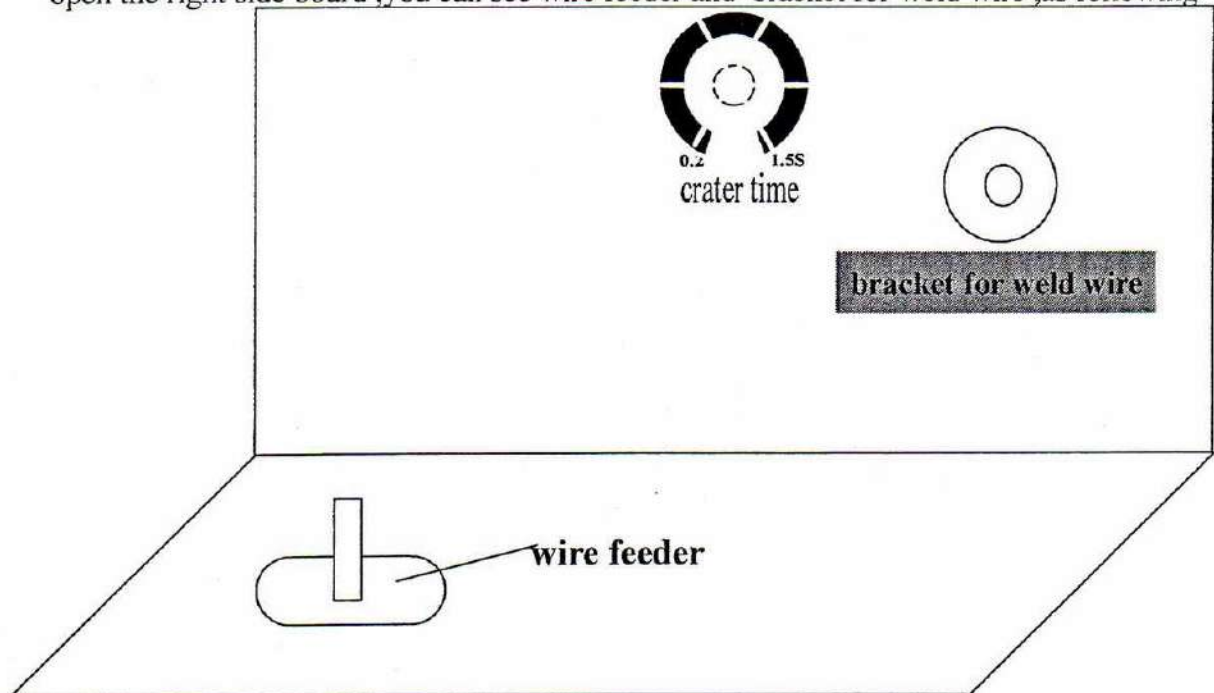

diagram 4

WM - 200 C BACK PANEL



open the right side board ,you can see wire feeder and bracket for weld wire ,as following



4.1.1 Power indicating

If the indicating light is on the control circuit connects the power already.

4.2 Warning

In order to remind the operator, we design the warnings as following .

★ excess temp

In the condition of more than 40°C temperature, large current is used continuously (I₂ > 200A), efficiency radiator temperature is more than 80 ± 5 °C ,overheat circuit begins working. The indicating light is on ,the power stop the welding automatically. The fan running continuously. If the temperature is lower, the indicating is off, the power can work and weld can be continued automatically ,Remind: Don't turn off the machine while the indicating overheat light is ON.

5. Safe and installation caution

Read the safe caution before installation and operation .It come down to the high voltage electricity, electric Arc and high temperature splash. So keep the safe regulation ,operate the machine properly, avoid the danger of electricity and high temperature arc.

★ Check if any damage or out looking of the welder.

★ Confirm the capacity: more than 30A.

★ Power source is grounded, diagram 6

★ Prohibit the combustible goods in the welding locale.

★ There is fire proof measure in the welding locale with favorable ventilated condition.

★ There is smoke discharge system if the welding is operated inside the house in order to keep the safety of workers.

★ The welding operator must be professional workers.

★ The operator must be fitted with safe accessories .Such as safe shoes, gloves, cover, welding mask and welding dress etc.

6. Explanation of installation

★ Check the products according to the packing list when open the package.

★ Grounded protection. Attached the diagram 6

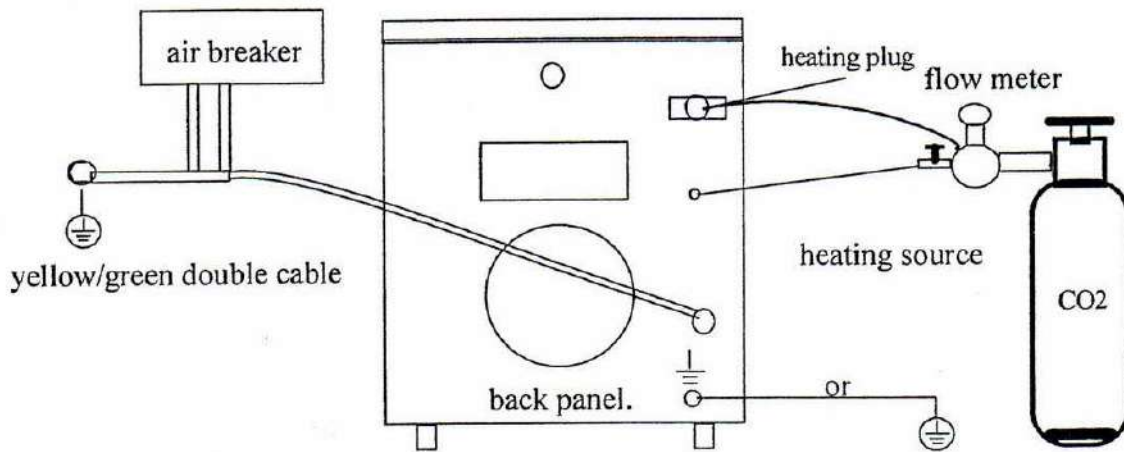

diagram 6

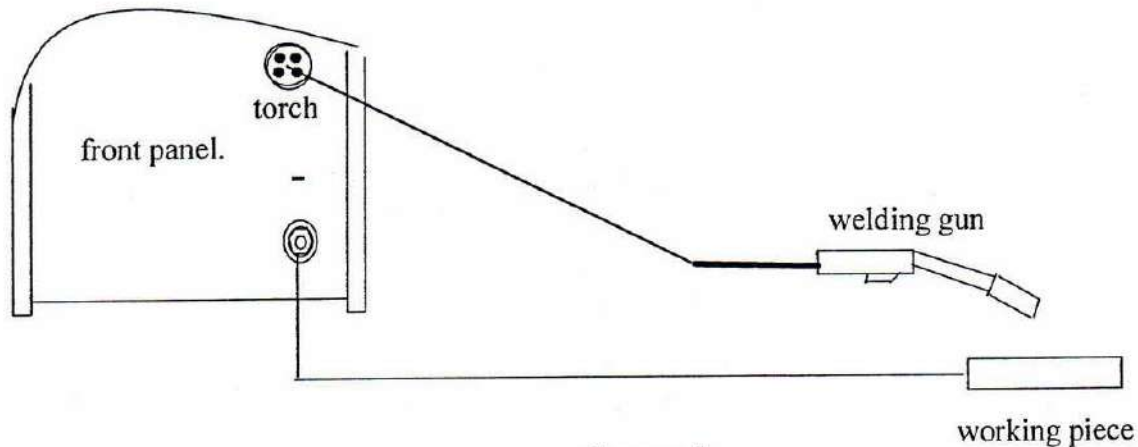

diagram 7

The power source is 220Vac/(50~60Hz) .The yellow/green double cable is grounding cable.Be sure to connect the yellow/green double cable into the grounding connection in the welding locale .Another way is selecting the M8 bolt on the back on the machine and connect the grounding as the diagram Attached the diagram 7

- ★ confirm the positive and negative marks and install the cable as diagram.
- ★ Insert the connectors inside the positive "+" and negative "-" position and roll it in 90. Do it oppositely when unloading the connectors.Keep the surface clean
- ★ Install the welding gun on the wire feeder and roll the welding gun in 90,then lock the bolt.
- ★If use the CO₂ heater,connected the heating power with 24V/5A power source.
- ★ Connect the gas pipe with the gas bottle according to the locale conditions. Check the air proof conditions to ensure the good airproof.

- ★ Connect the control cable of the wire feeder with the relative connector of the power WM - 200 C

7. Operatings

- ★ "ON" and "OFF" indicating switch on the FRONT panel.

- ★ Confirm the specification of the wire feed hose

- ★ Confirm the specification of nib base .It affects the extended length of the wire .

- ★ Confirm the specification of nib. It affects the electric resistance.

- ★ Confirm the wire slot of the roller is suitable for the diameter of the wire. Different diameter of wire select different wire slot. Otherwise it affects the wire feed result.

- ★ Confirm the pressure of the roller to avoid slipping.

If the pressure is not enough ,the wire feed is slow speed.

If the pressure is too much ,the wire will be anamorphic.

The wire feeder can not work properly.

- ★ Confirm the flow of the gas and air proof.

We suggest the gas flow to be "L" more than $10D$ (D -diameter of wire).If the selection is not proper,it also affects the welding quality.When using the CO_2 gas,please confirm if the heating power works properly or not .

- ★ Straight the hose of welding gun as much as possible .The bending radius can not be less than 200mm.Otherwise it affects the wire feeder.

7.1 Gas inspection

Press the switch of the gun before the wire roller is firmed,preset the gas flow through the meter to check if it is gas proof.Otherwise ,it affects the welding result.

7.2 Rip into the wire

Select the specification of the wire ,materials according to the craft requirements.Firm the bolt and press the button on the front panel.The speed of ripping wire can be controlled by the welding current knob.Unload the nib if necessary and load it again after the wire is out.

8.Suggested welding criterion

Select good quality welding wire to get the perfect welding result and smooth welding process .Low quality wire can affect the welding quality by resistance welding process and blocking etc.

8.1 Selection switch for wire diameter

Please refer to the function on 1.3

8.2 Selection for welding voltage and current Diagram 8

d(mm)	φ 0.8	φ 1.0	φ 1.2
suitable welding criterion	18~20V/80~120A*	17~18V/50~80A*	17~19V/50~100A*
	17~18V/50~80A*	18~19V/80~100A*	19~22V/100~150A*
		19~22V/100~160A*	22~24V/150~200A*
	19~22V/100~150A	22~24V/150~200A*	22~27V/200~250A*
		24~27V/200~250A	27~32V/250~315A

9. working elements

Diagram for the WM-200C working elements. Diagram 9

10. Maintenance

Check the safety measure be efficiency.

Get rid of the dust for the power source (FOR example, dry compressed air)

Before operating, Check the "+" "-" connectors of the power panel if they are relaxed

.Check the connection between the grounding cable and plug if they are relaxed, (If relaxed, the serious heating will damage the quick connectors)

.Check the fan if it works regularly. charge it if it is trouble.

Check the insulation and breakage of the input power cord

.Change it in time to ensure the safety.

check if there is any noisy for the wire feed motor.

Check the abrasion of the wire feed hose. Get rid of the dust inside of the hose. (!~2times / 40kg wire)

.Get rid of the splash inside the nib regularly to ensure the guaranteed result by the gas blow.

Check the abrasion of the nib. Change it in time. (suggest 1~2pieces nibs/40kg wire).

11. Troubles and Remedy

Troubles and remedy and remedy are as the form 10 as following

Troubles	Cause	Remedy
1. Fan not works properly	1. the fan line lose 2. Fan breakage	1. Connect the line 2. Change the fan
2. No indicating on the front panel	1. no power input 2. the fuse broken 3. Indicating light broken	1. Check the power 2. Change the fuse 15A/250V (back panel)

WIRE DIAGRAM

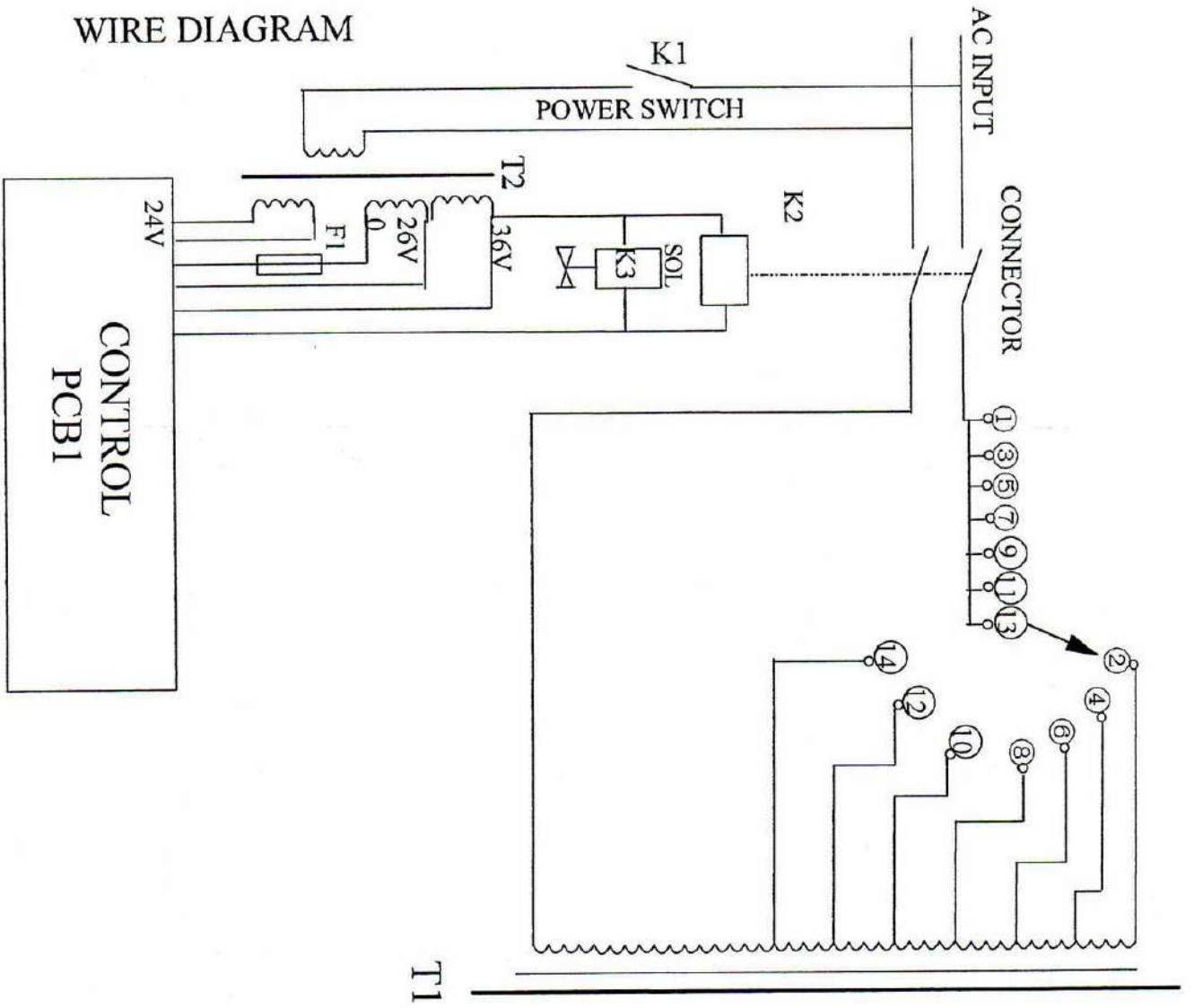

T1

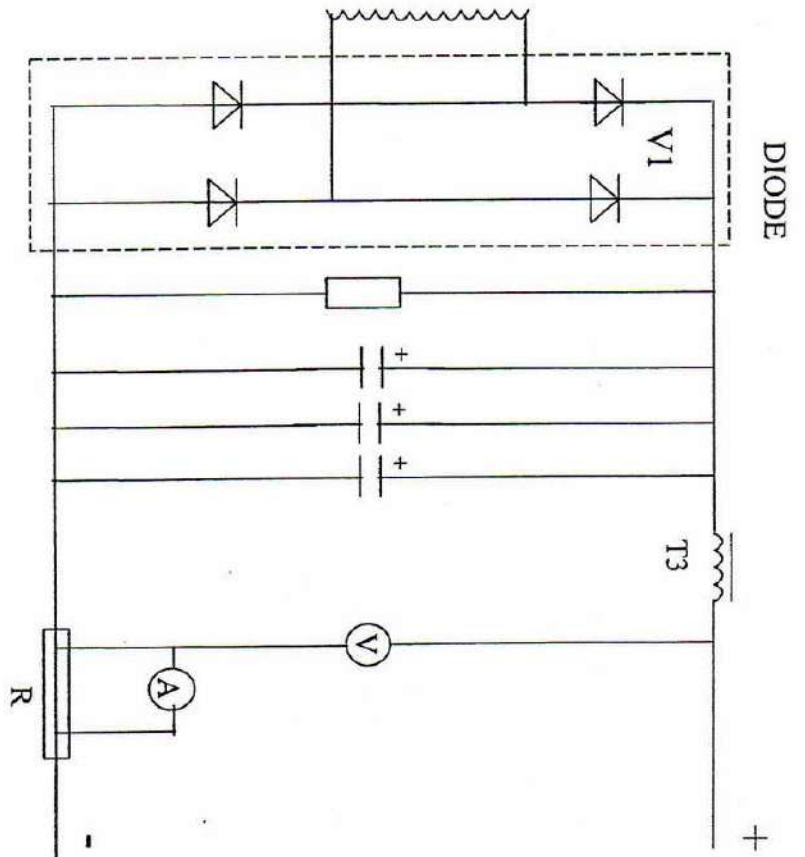

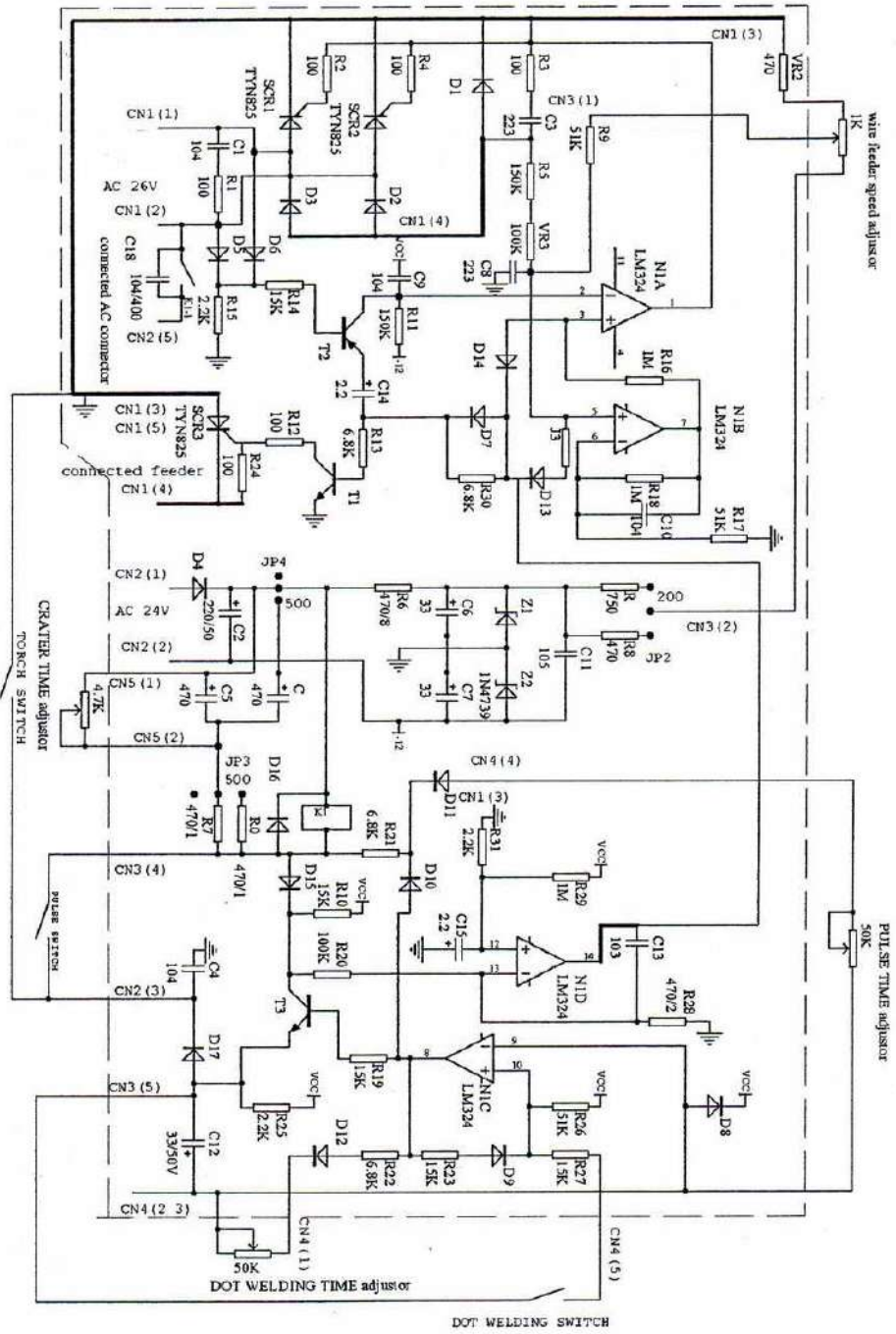

Title	
Size	Number
A1	
DATE: 11/11/2008 TIME: 10:25:00 AM FILE: E:\NSC\2008\2008111008	
Sheet of	Revision
1	1

Troubles	Cause	Remedy
3.Over heating light on	1.aeration is not good 2.The temperature is too high 3.over-load use 4.Thermostat broken 5.Control plate broken	1.get rid of the bar 0.5m around 2.Reduce the temperature 3.Reduce the use loading 4.Change the thermostat(JUC-OFF) 5.Check and change the control plate
4.Wire feeder not work	1.the fuse broken 2.the Cables are not 3.the wire blocked 4.the drive circuit broken 5.other reasons	1.Change the fuse 15A/250V (on back panel) 2.the Cables are not connected properly 3.Check the gun 4.Change the control panel 5.Contact with the manufacturer
6.Welding Voltage and welding current not adjustable	1.Voltage switch line fall down 2. Voltage switch broken 3.fuse broken 4.the cables not connectecl pr	1.Connect the lines 2.Change it 3.Change the fuse15A/250V(on back panel) 4.Check it

12.Enlarge the length of the welding cable

The length of the welding cable includes the total length of the welding circuit including the cables between the positive "+" of the power source. The cables longer, the section area thinner, it caused large voltage reducing and large voltage loss, More over, it affect the quality of the arc and the slag. So arrange the position of the welding machine properly to get the shortest cable.

The cable between the welding power and wire feeder is the shorter, the better. Otherwise it affects the maximum speed of wire feeder and the maximum welding current.

on the condition of low speed (lower than 12m/min), we can enlarge the cable to 20m when use ϕ 0.8~1.0

★ Straight the enlarged cable, otherwise it affects the arc stability.

13.Transportation, storage and environment conditions

★ The package (Wooden cases or cartons) of the manufacturer is suitable for air, sea, railway and highway (three class more) transportation..

★ Pay attention to the indication on the package during the transportation.

★ the environment conditions

A Temperature range operating 0°C ~ 40°C

transportation -25°C ~+55°C
B The air humidity 40°C 50%RH
20°C 90%RH

C The dust ,acid and causticity gas in the environment must be lower than the normal level
(The welding process produced not included)

D Rain proof when it is used outside.

14.Quality Guaranteed

If you have any problem of the quality ,please contact us in time .We generally have one year quality guarantee on condition that you operate or transport the machine properly according to the operation manual.

			
WARNING	<ul style="list-style-type: none"> ● Do not touch electrically live parts or electrode with skin or wet clothing. ● Insulate yourself from work and ground. 	<ul style="list-style-type: none"> ● Keep flammable materials away. 	<ul style="list-style-type: none"> ● Wear eye, ear and body protection.
Spanish AVISO DE PRECAUCION	<ul style="list-style-type: none"> ● No toque las partes o los electrodos bajo carga con la piel o ropa mojada. ● Aíslese del trabajo y de la tierra. 	<ul style="list-style-type: none"> ● Mantenga el material combustible fuera del área de trabajo. 	<ul style="list-style-type: none"> ● Protéjase los ojos, los oídos y el cuerpo.
French ATTENTION	<ul style="list-style-type: none"> ● Ne laissez ni la peau ni des vêtements mouillés entrer en contact avec des pièces sous tension. ● Isolez-vous du travail et de la terre. 	<ul style="list-style-type: none"> ● Gardez à l'écart de tout matériel inflammable. 	<ul style="list-style-type: none"> ● Protégez vos yeux, vos oreilles et votre corps.
German WARNUNG	<ul style="list-style-type: none"> ● Berühren Sie keine stromführenden Teile oder Elektroden mit Ihrem Körper oder feuchter Kleidung! ● Isolieren Sie sich von den Elektroden und dem Erdboden! 	<ul style="list-style-type: none"> ● Entfernen Sie brennbares Material! 	<ul style="list-style-type: none"> ● Tragen Sie Augen-, Ohren- und Körperschutz!
Portuguese ATENÇÃO	<ul style="list-style-type: none"> ● Não toque partes elétricas e electrodos com a pele ou roupa molhada. ● Isole-se da peça e terra. 	<ul style="list-style-type: none"> ● Mantenha inflamáveis bem guardados. 	<ul style="list-style-type: none"> ● Use proteção para a vista, ouvido e corpo.
Japanese 注意事項	<ul style="list-style-type: none"> ● 通電中の電気部品、又は溶材にヒフやぬれた布で触れないこと。 ● 施工物やアースから身体が絶縁されている様にして下さい。 	<ul style="list-style-type: none"> ● 燃えやすいものの側での溶接作業は絶対にしてはなりません。 	<ul style="list-style-type: none"> ● 目、耳及び身体に保護具をして下さい。
Chinese 警告	<ul style="list-style-type: none"> ● 皮肤或湿衣物切勿接触带电部件及焊條。 ● 使你自已與地面和工件絕緣。 	<ul style="list-style-type: none"> ● 把一切易燃物品移離工作場所。 	<ul style="list-style-type: none"> ● 佩戴眼、耳及身體勞動保護用具。
Korean 위험	<ul style="list-style-type: none"> ● 전도체나 용접봉을 젖은 헝겍 또는 피부를 절대 접촉하지 마십시오. ● 도재와 접지를 접촉하지 마십시오. 	<ul style="list-style-type: none"> ● 인화성 물질을 접근시키지 마십시오. 	<ul style="list-style-type: none"> ● 눈, 귀의 몸에 보호장구를 착용하십시오.
Arabic تحذير	<ul style="list-style-type: none"> ● لا تلمس الأجزاء التي يسري فيها التيار الكهربائي أو الأقطاب بجند الجسم أو بالملابس المبللة بالماء. ● ضع عازلا على جسمك خلال العمل. 	<ul style="list-style-type: none"> ● ضع المواد القابلة للاشتعال في مكان بعيد. 	<ul style="list-style-type: none"> ● ضع أدوات وملابس واقية على عينيك وأذنيك وجسمك.

READ AND UNDERSTAND THE MANUFACTURER'S INSTRUCTION FOR THIS EQUIPMENT AND THE CONSUMABLES TO BE USED AND FOLLOW YOUR EMPLOYER'S SAFETY PRACTICES.

SE RECOMIENDA LEER Y ENTENDER LAS INSTRUCCIONES DEL FABRICANTE PARA EL USO DE ESTE EQUIPO Y LOS CONSUMIBLES QUE VA A UTILIZAR, SIGA LAS MEDIDAS DE SEGURIDAD DE SU SUPERVISOR.

LISEZ ET COMPRENEZ LES INSTRUCTIONS DU FABRICANT EN CE QUI REGARDE CET EQUIPMENT ET LES PRODUITS A ETRE EMPLOYES ET SUIVEZ LES PROCEDURES DE SECURITE DE VOTRE EMPLOYEUR.

LESEN SIE UND BEFOLGEN SIE DIE BETRIEBSANLEITUNG DER ANLAGE UND DEN ELEKTRODENEINSATZ DES HERSTELLERS. DIE UNFALLVERHÜTUNGSVORSCHRIFTEN DES ARBEITGEBERS SIND EBENFALLS ZU BEACHTEN.

			
<ul style="list-style-type: none"> ● Keep your head out of fumes. ● Use ventilation or exhaust to remove fumes from breathing zone. 	<ul style="list-style-type: none"> ● Turn power off before servicing. 	<ul style="list-style-type: none"> ● Do not operate with panel open or guards off. 	WARNING
<ul style="list-style-type: none"> ● Los humos fuera de la zona de respiración. ● Mantenga la cabeza fuera de los humos. Utilice ventilación o aspiración para gases. 	<ul style="list-style-type: none"> ● Desconectar el cable de alimentación de poder de la máquina antes de iniciar cualquier servicio. 	<ul style="list-style-type: none"> ● No operar con panel abierto o guardas quitadas. 	Spanish AVISO DE PRECAUCION
<ul style="list-style-type: none"> ● Gardez la tête à l'écart des fumées. ● Utilisez un ventilateur ou un aspirateur pour ôter les fumées des zones de travail. 	<ul style="list-style-type: none"> ● Débranchez le courant avant l'entretien. 	<ul style="list-style-type: none"> ● N'opérez pas avec les panneaux ouverts ou avec les dispositifs de protection enlevés. 	French ATTENTION
<ul style="list-style-type: none"> ● Vermeiden Sie das Einatmen von Schweißrauch! ● Sorgen Sie für gute Be- und Entlüftung des Arbeitsplatzes! 	<ul style="list-style-type: none"> ● Strom vor Wartungsarbeiten abschalten! (Netzstrom völlig öffnen; Maschine anhalten!) 	<ul style="list-style-type: none"> ● Anlage nie ohne Schutzgehäuse oder Innenschutzverkleidung in Betrieb setzen! 	German WARNUNG
<ul style="list-style-type: none"> ● Mantenha seu rosto da fumaça. ● Use ventilação e exaustão para remover fumo da zona respiratória. 	<ul style="list-style-type: none"> ● Não opere com as tampas removidas. ● Desligue a corrente antes de fazer serviço. ● Não toque as partes elétricas nuas. 	<ul style="list-style-type: none"> ● Mantenha-se afastado das partes moventes. ● Não opere com os painéis abertos ou guardas removidas. 	Portuguese ATENÇÃO
<ul style="list-style-type: none"> ● ヒュームから頭を離すようにして下さい。 ● 換気や排煙に十分留意して下さい。 	<ul style="list-style-type: none"> ● メンテナンス・サービスに取りかかる際には、まず電源スイッチを必ず切して下さい。 	<ul style="list-style-type: none"> ● パネルやカバーを取り外したままで機械操作をしないで下さい。 	Japanese 注意事項
<ul style="list-style-type: none"> ● 頭部遠離煙霧。 ● 在呼吸區使用通風或排風器除煙。 	<ul style="list-style-type: none"> ● 維修前切斷電源。 	<ul style="list-style-type: none"> ● 儀表板打開或沒有安全罩時不準作業。 	Chinese 警告
<ul style="list-style-type: none"> ● 얼굴로부터 용접가스를 멀리하십시오. ● 호흡지역으로부터 용접가스를 제거하기 위해 가스제거기나 등풍기들 사용하십시오. 	<ul style="list-style-type: none"> ● 보수전에 전원을 차단하십시오. 	<ul style="list-style-type: none"> ● 판넬이 열린 상태로 작동치 마십시오. 	Korean 위험
<ul style="list-style-type: none"> ● ابعء رأسك بعيداً عن الدخان. ● استعمل التهوية أو جهاز ضغط الدخان للخارج لكي تبعء الدخان عن المنطقة التي تتنفس فيها. 	<ul style="list-style-type: none"> ● اقطع التيار الكهربائي قبل القيام بأية صيانة. 	<ul style="list-style-type: none"> ● لا تشغل هذا الجهاز اذا كانت الاغطية الحديدية الواقية ليست عليه. 	Arabic تحذير

LEIA E COMPREENDA AS INSTRUÇÕES DO FABRICANTE PARA ESTE EQUIPAMENTO E AS PARTES DE USO, E SIGA AS PRÁTICAS DE SEGURANÇA DO EMPREGADOR.

使う機械や溶材のメーカーの指示書をよく読み、まず理解して下さい。そして貴社の安全規定に従って下さい。

請詳細閱讀並理解製造廠提供的說明以及應該使用的銀焊材料，並請遵守貴方的有關勞動保護規定。

이 제품에 동봉된 작업지침서를 숙지하시고 귀사의 작업자 안전수칙을 준수하시기 바랍니다.

اقرأ بتمعن وأفهم تعليمات المصنع المنتج لهذه المعدات والمواد قبل استعمالها واتبع تعليمات الوقاية لصاحب العمل.